



## **SLIDE RAIL INSTALLATION INSTRUCTIONS**



### **For Cisco C170, M170, and S170 Appliances and Cisco 5512-X, 5515-X, 5525-X, 5545-X, 5555-X Adaptive Security Appliances and Cisco IPS 4345 and 4360**

- 1** Verify the Box Contents
  - 2** Disassemble the Slide Rail
  - 3** Attach Inner Rails to the Chassis
  - 4** Verify the Rack Type
  - 5** Round Hole Racks
  - 6** Threaded Hole Racks
  - 7** Attach the Outer Slide Rail to Round and Square Hole Racks
  - 8** Attach the Outer Slide Rail to Threaded Hole Racks
  - 9** Install the Chassis
  - 10** Secure the Chassis
- Obtaining Documentation and Submitting a Service Request

# 1 Verify the Box Contents

Remove the contents from the box and verify that it contains the following items for all rack types:

- (A) Slide Rails (x2) (preconfigured for square hole racks)
- (B) Phillips flat-head screws for Inner Slide (x2)

For round hole racks, you also need the following:

- (C) Round Hole Inserts (x4)

For threaded hole racks, you also need the following:

- (D) Threaded Hole Brackets (x2)
- (E) Threaded Hole Standoffs (x2)
- (F) Phillips pan-head screws for threaded hole racks (x8)

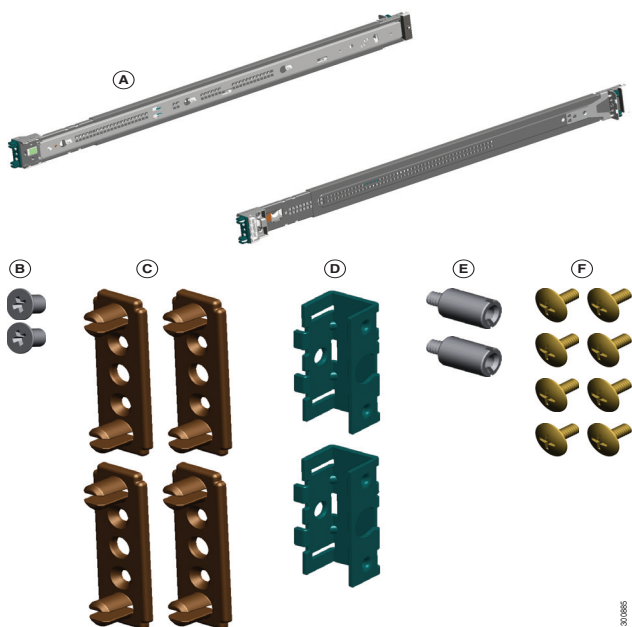

## Tools Required:

- Phillips screwdriver
- Flat-head screwdriver (for threaded hole racks)

## 2 Disassemble the Slide Rail

Pull the inner slide rail from the outer slide rail.

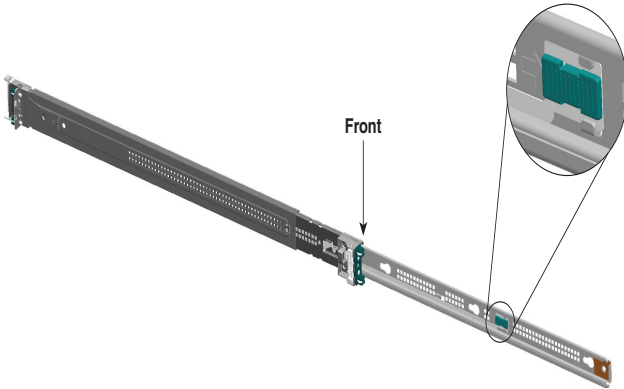

Slide the plastic tab forward, and pull the inner slide rail to disconnect it from the outer slide rail.

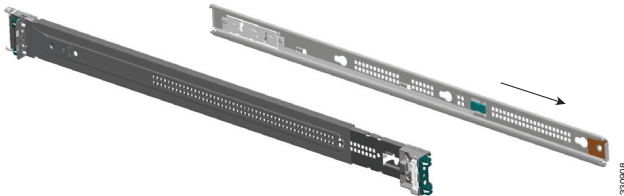

Repeat the steps on this page for the other slide rail.

### 3 Attach Inner Rails to the Chassis

Align one of the inner slide rail key holes over the chassis shoulder screw on one side. Slide the inner slide rail forward so that the shoulder screw is securely in place.



Use a Phillips screwdriver to secure the inner slide rail with one Phillips flat-head screw (B).



Secure the other inner slide rail to the chassis by repeating the previous steps on this page.



## 4 Verify the Rack Type

The slide rails are pre-assembled for square hole racks. See the following steps for the different rack types:

- **Square hole racks.** Go to “Attach the Outer Slide Rail to Round and Square Hole Racks” on page 8.
- **Round hole racks.** Go to “Round Hole Racks” on page 6.
- **Threaded hole racks.** Go to “Threaded Hole Racks” on page 7.

The following figure shows the slide rail with square hole rack inserts.

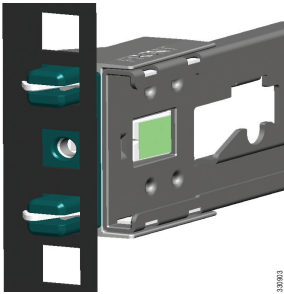

## 5 Round Hole Racks

Using a Phillips head screwdriver, remove the square insert from the rear of the rail. Keep the two Phillips head screws.

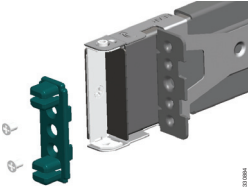

Remove the square insert from the front of the rail. Keep the two Phillips head screws.

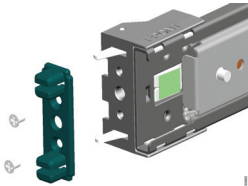

Align the round hole insert © to the rear of the rail, and secure it with two of the saved screws.

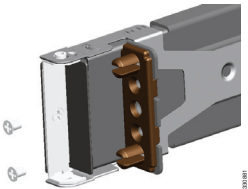

Align the round hole insert © to the front of the rail over the hooks, and secure it with two of the saved screws.

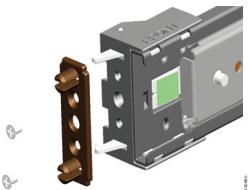

See “Attach the Outer Slide Rail to Round and Square Hole Racks” on page 8.

## 6 Threaded Hole Racks

Using a Phillips head screwdriver, remove the square hole insert from the rear of the rail.

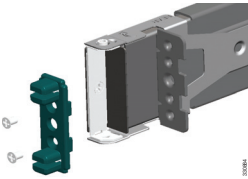

Remove the square hole insert from the front of the rail.

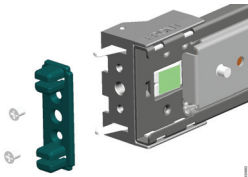

Align the threaded hole bracket <sup>Ⓓ</sup> to the front of the rail over the hooks. Secure it with the threaded hole standoff <sup>Ⓔ</sup> using a flat-head screwdriver.

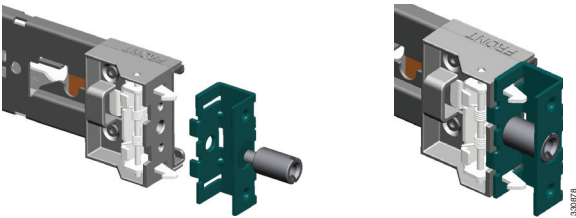

No additional hardware is necessary for the rear adapter.

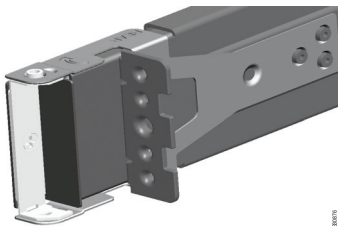

Repeat these steps page for the other slide rail. Go to the “Attach the Outer Slide Rail to Threaded Hole Racks” section on page 9.

## 7 Attach the Outer Slide Rail to Round and Square Hole Racks

Align the front of one of the outer slide rails with the rack upright, push it forward, and click it into place. Align the rear of the outer slide rail with the rack upright, pull the release tab, push the slide rail toward the rack, release the tab, and click it into place.



### Note

For racks shorter than 24 inches in depth, remove the rear bracket with a Phillips head screwdriver, pull the release tab, and adjust the slide rail to the appropriate length for the rack.

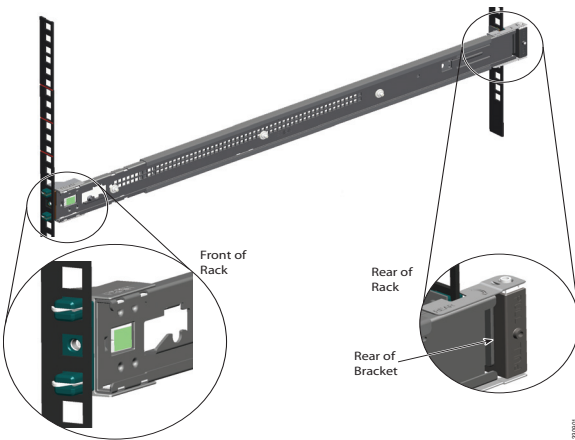

Secure the other outer slide rail to the rack by repeating the previous steps.

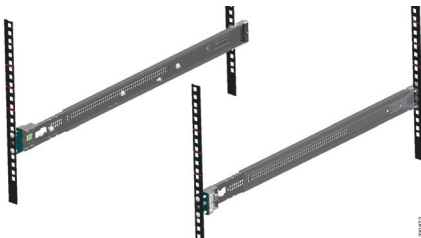

Go to the “Install the Chassis” section on page 10.



## 8 Attach the Outer Slide Rail to Threaded Hole Racks

Align the slide rail to the front rack post. Secure it with two of the included Phillips pan-head screws (F).

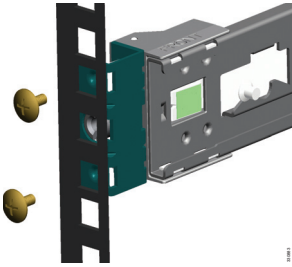

Align the slide rail to the rear rack post. Secure it with two of the included Phillips pan-head screws (F).

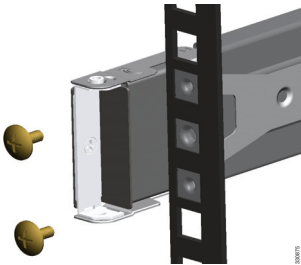

Align the other slide rail to the rack by repeating the previous steps on this page.

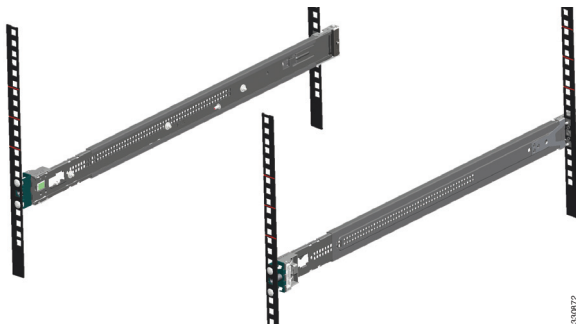

Go to the “Install the Chassis” section on page 10.

## 9 Install the Chassis

Align the inner slide rails to the outer slide rails. Install the inner slide rails into the outer slide rails until they lock into place.

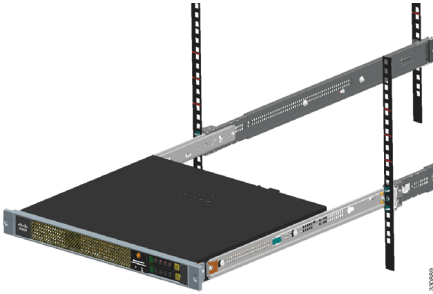

Pull the side release tabs to unlock the inner slide rail, and push the chassis assembly into the rack.

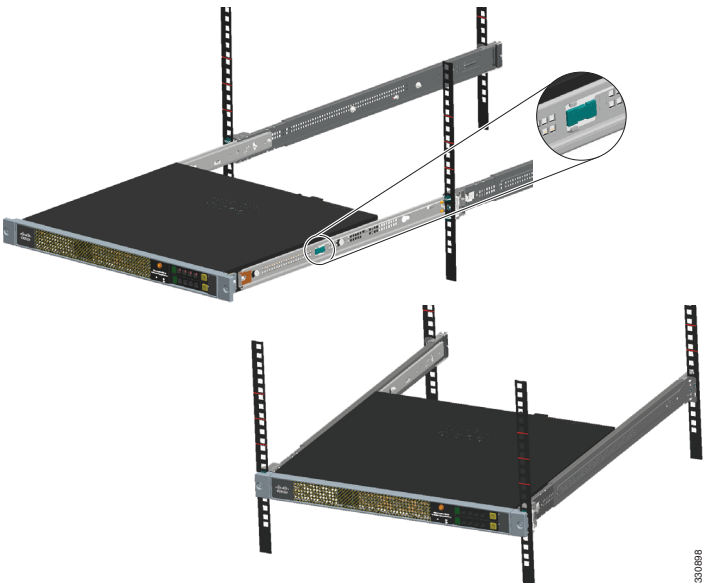

## 10 Secure the Chassis

Secure the chassis to the rack with the front captive screws.

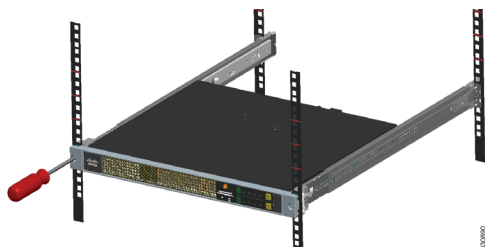

## Obtaining Documentation and Submitting a Service Request

For information on obtaining documentation, submitting a service request, and gathering additional information, see the monthly *What's New in Cisco Product Documentation*, which also lists all new and revised Cisco technical documentation, at: <http://www.cisco.com/en/US/docs/general/whatsnew/whatsnew.html>

Subscribe to the *What's New in Cisco Product Documentation* as an RSS feed and set content to be delivered directly to your desktop using a reader application. The RSS feeds are a free service. Cisco currently supports RSS Version 2.0.

Cisco and the Cisco logo are trademarks or registered trademarks of Cisco and/or its affiliates in the U.S. and other countries. To view a list of Cisco trademarks, go to this URL: [www.cisco.com/go/trademarks](http://www.cisco.com/go/trademarks). Third-party trademarks mentioned are the property of their respective owners. The use of the word partner does not imply a partnership relationship between Cisco and any other company. (1110R)

© 2012 Cisco Systems, Inc. All rights reserved.



---

**Americas Headquarters**  
Cisco Systems, Inc.  
San Jose, CA

**Asia Pacific Headquarters**  
Cisco Systems (USA) Pte. Ltd.  
Singapore

**Europe Headquarters**  
Cisco Systems International BV Amsterdam,  
The Netherlands

Cisco has more than 200 offices worldwide. Addresses, phone numbers, and fax numbers are listed on the Cisco Website at [www.cisco.com/go/offices](http://www.cisco.com/go/offices).

---

Printed in the USA on recycled paper containing 10% postconsumer waste.